

Simplicity

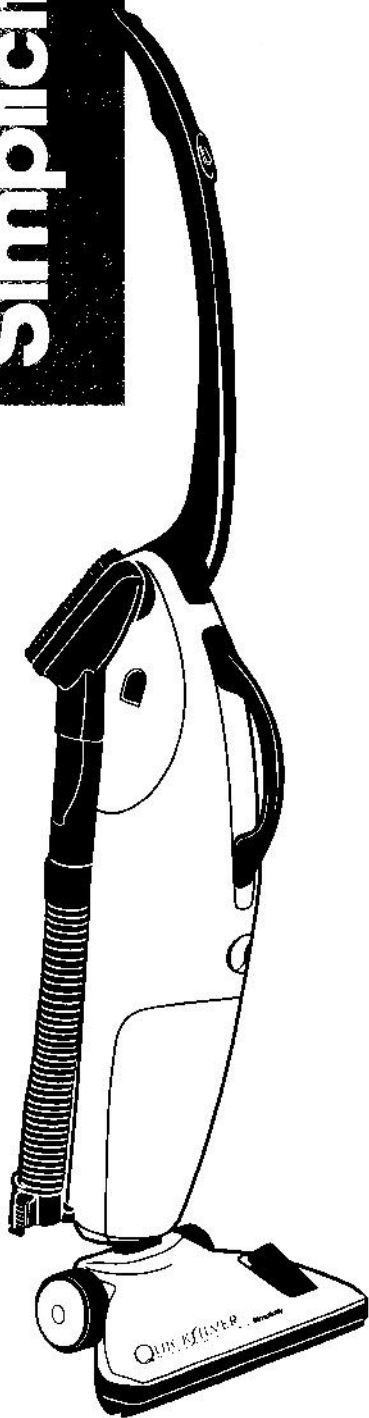

Owner's Manual MODEL QS1

QUICKSILVER™

MULTIPLE SURFACE VACUUM

Thank you for purchasing our product.
To ensure the best results using the QuickSilver Multiple Surface Vacuum, please read this manual first and keep it for future reference.

To locate your nearest Authorized Simplicity Dealer for sales or service, please visit our website at www.simplicityvac.com or call 888-974-6759.

IMPORTANT SAFEGUARDS

Read All Instructions Carefully Before Using.

WARNING

To reduce the risk of fire, electrical shock, injury to persons or damage when using your vacuum cleaner, follow basic safety precautions including the following;

1. Use only as described in this manual.
Use only manufacturer's recommended attachments.
2. Do not leave appliance when plugged in. Unplug from outlet when not in use and before servicing.
3. Do not use outdoors or on wet surfaces.
Do not use motorized nozzle on wet surfaces (Optional).
4. Do not allow to be used as a toy. Close attention is necessary when used by or near children.
5. Do not use with damaged cord or plug. If appliance is not working as it should, has been dropped, damaged, left outdoors, or dropped into water, return it to a service center.
6. Do not pull or carry by cord, use cord as a handle, close a door on cord, or pull cord around sharp edges or corners. Do not run appliance over cord. Keep cord away from heated surfaces.
7. Do not unplug by pulling on cord. To unplug, grasp the plug, not the cord.
8. Do not handle plug or appliance with wet hands.
9. Do not put any object into openings. Do not use with any opening blocked; keep free of lint, hair, and anything that may reduce air flow.
10. Keep hair, loose clothing, fingers, and all parts of body away from openings and moving parts(Handle, Brush, etc.).
11. Turn off all controls(switch) before unplugging.
12. Use extra care when cleaning on stairs.
13. This appliance is intended for household use only and not for commercial or industrial use.
14. It must be replaced by the manufacturer or its service agent or a similarly qualified person in order to avoid a hazard.
15. Always turn off this appliance before connecting or disconnecting motorized nozzle(Optional).

SAVE THESE INSTRUCTIONS

IMPORTANT SAFETY INSTRUCTIONS

This vacuum cleaner should only be used for normal dry household dust and dirt. The manufacturer cannot be held responsible for any damage caused by use or operation of the cleaner contrary to these instructions.

If the cleaner is wrongly operated for a purpose other than that for which it is intended, no liability can be accepted for any possible damage.

- Do not use the cleaner to pick up sharp hard objects, small toys, pins, etc. They may damage the cleaner or dust bag.
- Do not pick up anything that is burning or smoking, such as cigarettes ends, matches or hot ashes.
- Do not pick up flammable or combustible liquids, such as gasoline, or use in areas where they may be present.

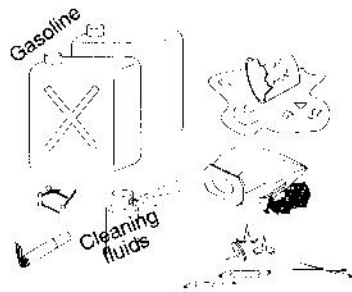

- Hold plug when rewinding onto cord reel. Do not allow plug to whip when rewinding.
- Do not pull the power cord out beyond the specified length(15feet).

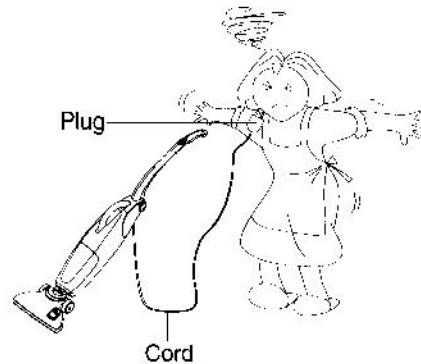

- Never use a damaged dust bag.
- Do not use without dust bag and motor protection filter in place.



- This product is equipped with a polarized alternating current line plug(a plug having one wider than the other). This plug will fit into the power outlet only one way. This is a safety feature. If you are unable to insert the plug fully into the outlet, try reversing the plug. If the plug should still fail to fit, contact an electrician to replace the obsolete outlet. Do not defeat the safety purpose of the polarized plug.

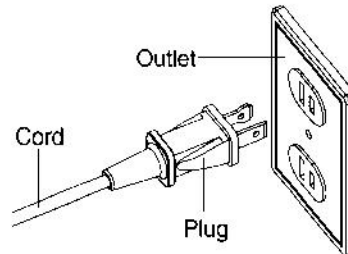

PARTS AND USING

ON/OFF SWITCH

- Turn the cleaner on by pressing the ON/OFF switch on the handle.

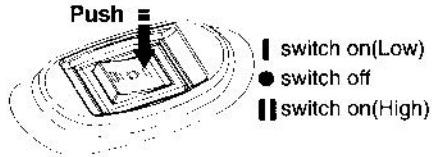

CORD REWIND BUTTON

- Press the cord rewind button to rewind the cord.

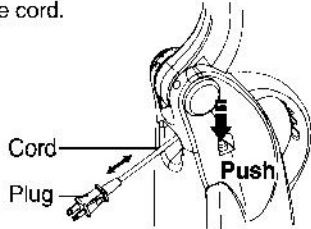

HARD FLOOR/CARPET PEDAL

- Select the appropriate setting of the pedal according to the surface to be cleaned.

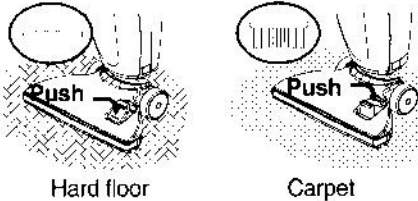

SOCKET FOR POWER BRUSH

- Insert the power brush plug into the socket.

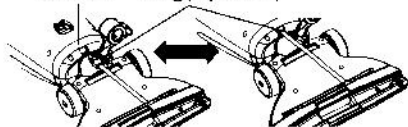

HOSE STORAGE HOOK

- Insert the hose storage hook into the groove.

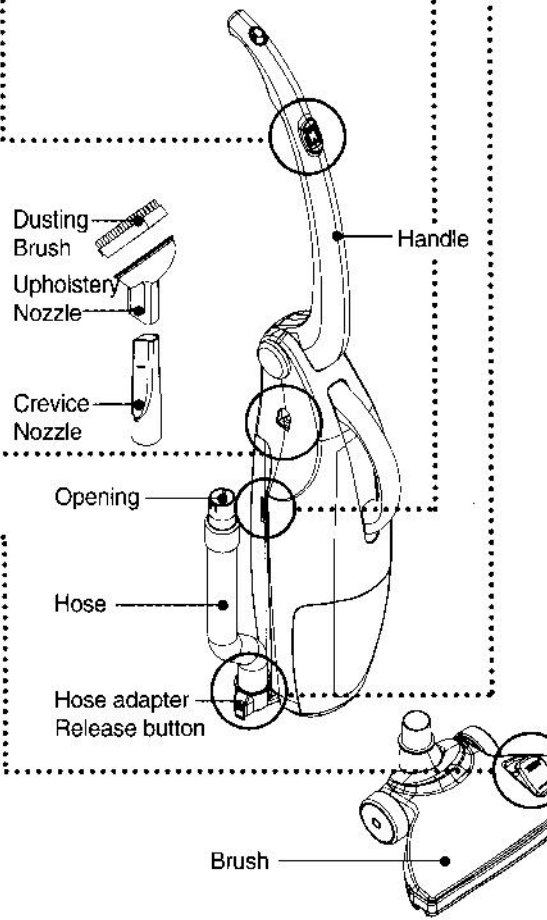
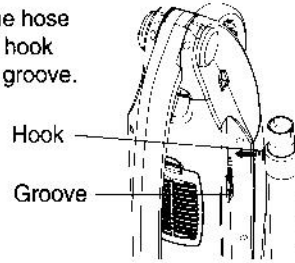

BRUSH RELEASE BUTTON, HOSE ADAPTER

- Press the brush release button and pull the brush.
- Rotate the hose adapter to the suction opening until you hear it 'click'.

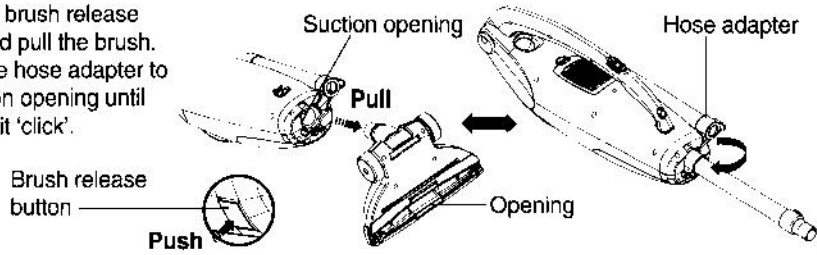

HANDLE LOCK BUTTON

- Press the handle lock button and move the handle downwards.

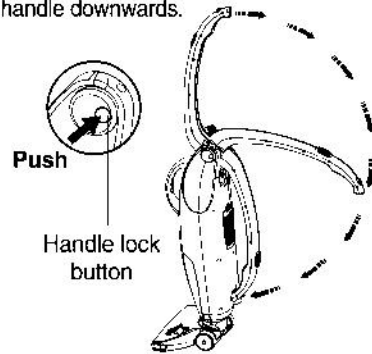

HANDLE RELEASE BUTTON

- Press the handle release button and move the handle upwards.

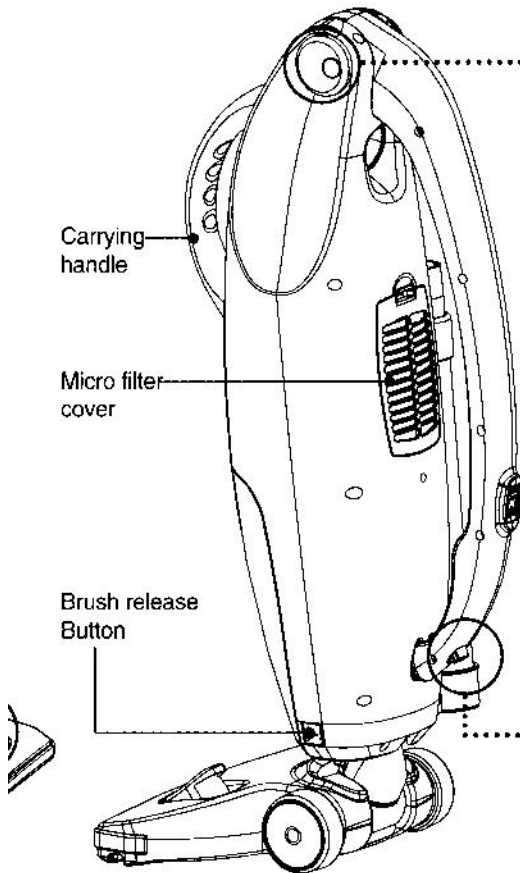
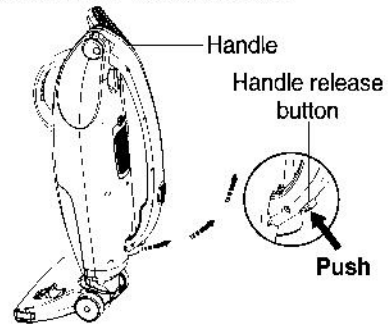

HOW TO USE

Using the vacuum cleaner in the stick mode

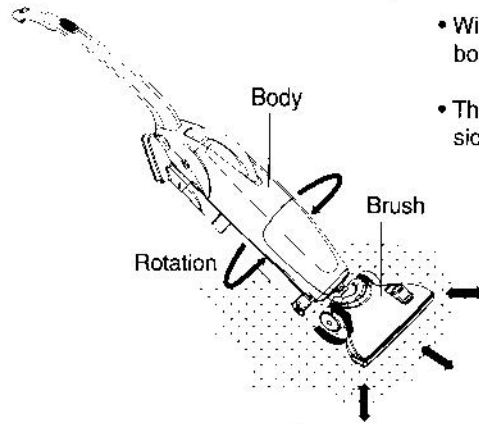

- With your foot resting on the brush, tilt the body of the cleaner down.
- The brush can be adjusted to the right side and the left side by rotating the body.

Using the vacuum cleaner in the shoulder mode

- Assemble the clips and rotate the hose adapter to the suction opening until you hear it 'click'.

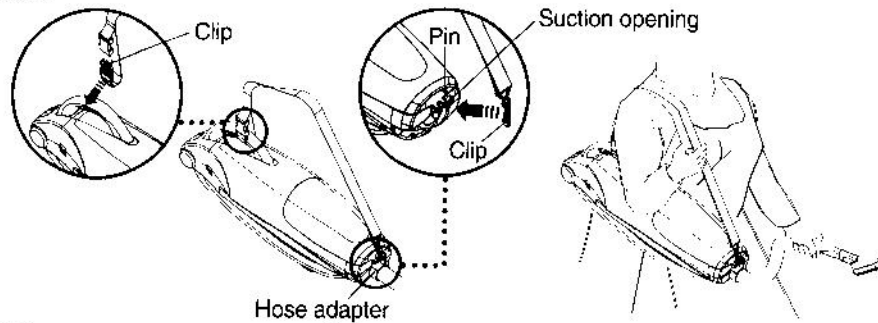

Using the vacuum cleaner in the hand-held mode

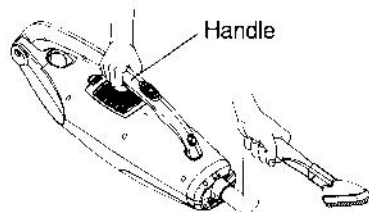

Moving the vacuum cleaner by hand



REPLACING THE DUST BAG

- Open the dust cover and push the dust bag holder in the direction of the arrow mark and take out the old dust bag.
- When replacing the dust bag, place the hard board of the dust bag between the two guides and insert the lower part of it into the bottom hooks and fix the upper part of it with the dust bag holder.
- The dust cover can not be closed completely when the dust bag is set wrong.

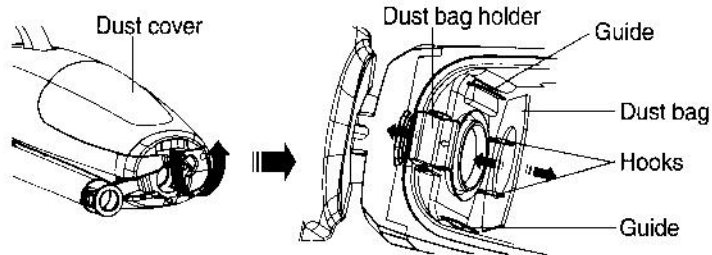

USING ATTACHMENTS

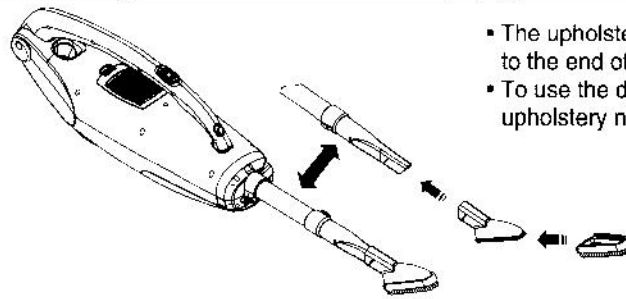

- The upholstery nozzle can be connected to the end of the crevice nozzle.
- To use the dusting brush, slide it into the upholstery nozzle.

CLEANING THE FILTERS

- Take out the motor protection filter and clean it.

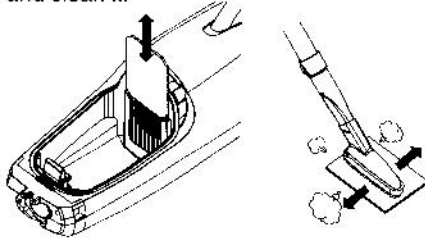

- Open the micro filter cover and take the micro- filter out of it.
- Replace the micro- filter with a new one.

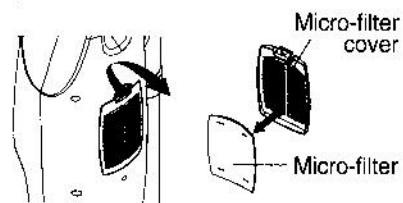

BEFORE ASKING FOR SERVICE

- Please check each item below if you have trouble with your cleaner.
- Before checking, ensure the cleaner is unplugged from the power supply.

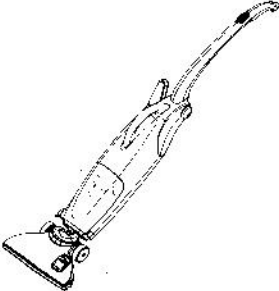
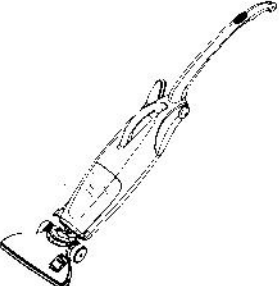
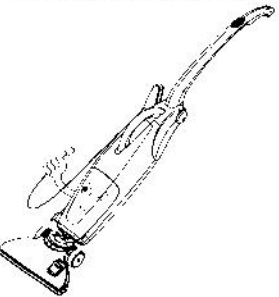
PROBLEM	CHECK POINT	SOLUTION
<ul style="list-style-type: none"> • Suction power is weak 	<ul style="list-style-type: none"> • Dust bag • Brush • Accessories 	<ul style="list-style-type: none"> • If it is filled with dust, change it. • Remove hair, string and lint build-up in the brush area. • If clogged or blocked, remove the object.
<ul style="list-style-type: none"> • The cleaner does not work 	<ul style="list-style-type: none"> • Plug On/Off switch • When the dust bag is full or openings are blocked, the over heating protection for the motor is activated automatically. 	<ul style="list-style-type: none"> • Plug in firmly, push On/Off switch to On. • Switch off and unplug the cleaner and check the dust bag, openings and blockages. The cleaner can be switched on again after about 30 minutes.
<ul style="list-style-type: none"> • Power cord does not rewind.  <ul style="list-style-type: none"> • Power cord is not pulled out of the cleaner. 	<ul style="list-style-type: none"> • Power cord 	<ul style="list-style-type: none"> • Pull the power cord out a little and press the cord rewind button. • Do not pull it by force. Rewind it a little by pressing the cord rewind button and pull it out.